

Milling spindles / V LINE

Allround talent for machining technology

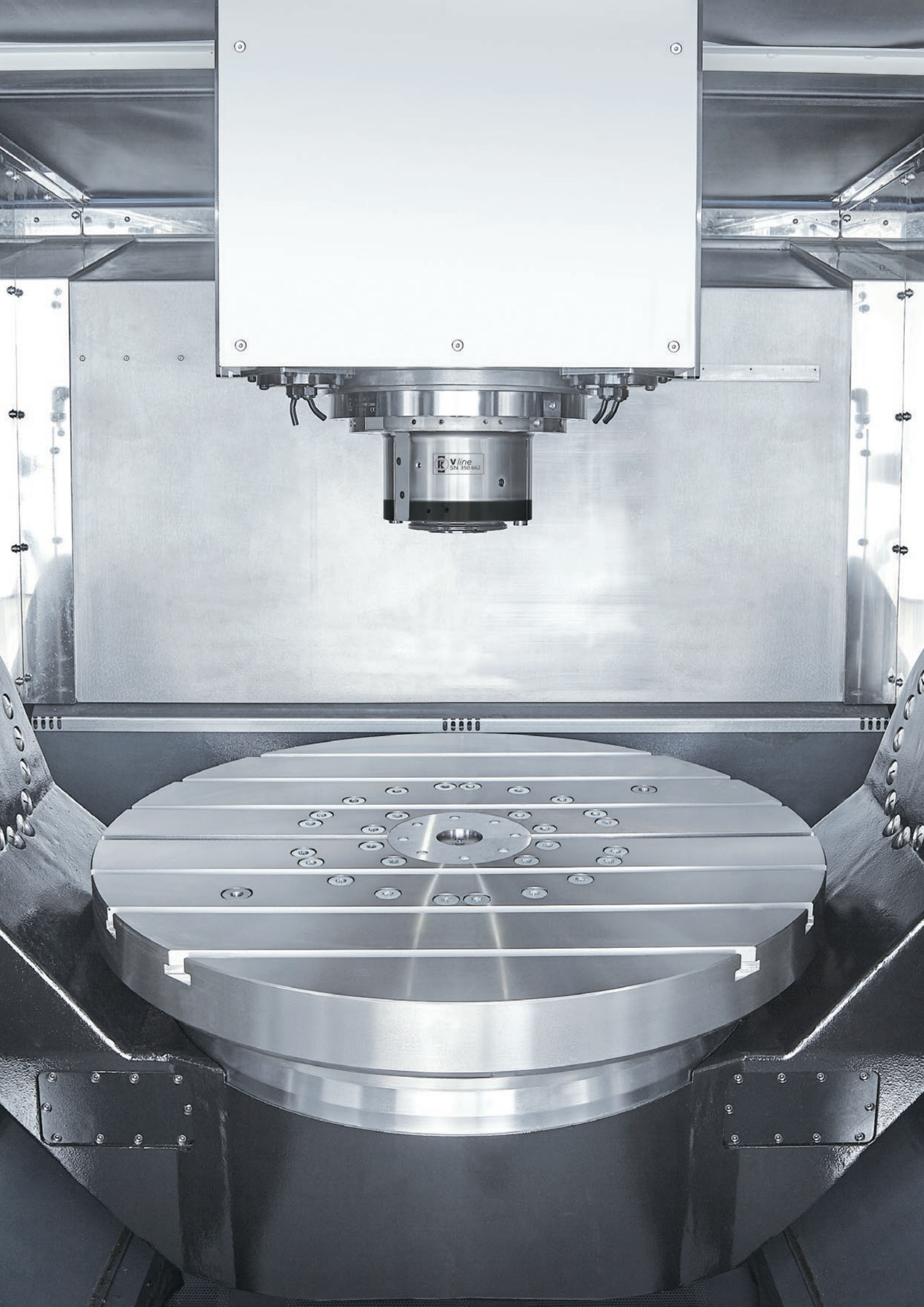



KESSLER SPINDLELINES

Spindle technology with passion and expertise

The KESSLER milling spindles have a modular design.

Configure your own milling spindle model by specifying the installation position, motor, speed, bearing, lubrication and sensor system – the perfect customized solution for your individual branch and application needs.

KESSLER offers more: We are an internationally successful company with specialist expertise that enables us to provide comprehensive consultation in the design and manufacture of individual components, and project planning of complex systems. We use the very latest technology and analytical processes to test our components under realistic conditions, so that our products help your business to stay flexible and maintain its competitive edge.

Our in-house development division is supported by extensive calculation and analysis skills and covers everything from direct drive technology to the construction of all-in-one systems. Furthermore, optimized production and assembly lines provide the framework for stable processes and the superior quality of our products.

End-to-end precision from the components to the on-site service

Founded in 1923 by Franz Kessler, the company has developed to become the leading supplier of motor spindles as well as directly driven 2-axis heads and rotary tilt tables for the machine tool industry. KESSLER is proud to list many major companies from the mechanical engineering sector amongst its long-standing customers.



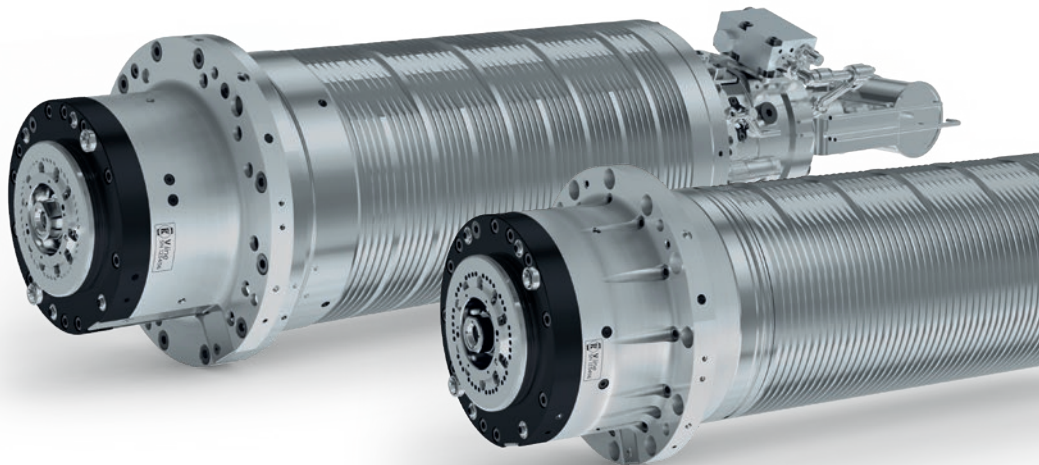

With the expertise of almost 100 years, KESSLER is continuously developing and optimising its products. The KESSLER product range serves a wide range of sectors, processes and applications. Close cooperation with our customers remains our key focus. The extensive product range, from hightech spindles, 2-axis heads, rotary and rotary tilt tables to motors and direct drive systems, enables KESSLER to implement customised solutions with speed and flexibility.

As your service partner, service is our matter of trust and reliability. KESSLER has an established global network of technology and service centres.



Masterpieces

KESSLER provides tailor-made spindle technology to suit your needs:
Individual, flexible, modular and suitable for all areas of application

<p>HCLINE</p> <ul style="list-style-type: none"> ○ Heavy cutting ○ Aerospace titanium machining ○ Machining of large-scale parts 								HC500	HC600	
<p>PCLINE</p> <ul style="list-style-type: none"> ○ High speed ○ High power ○ High accuracy 			PC80		PC100			PC400		
<p>HLINE</p> <ul style="list-style-type: none"> ○ Horizontal installation ○ Very short acceleration and braking times 		H80		H100		H200				
<p>MTLINE</p> <ul style="list-style-type: none"> ○ Very short construction ○ Used in tilting heads, turning and milling operations 		MT80			MT100			MT400	MT500	MT600
<p>VLINE</p> <ul style="list-style-type: none"> ○ Vertical installation ○ Tilting ○ Allrounder 					V100		V200	V400		
Spindle fitting Ø (mm)										
○ Open cooling housing		170	170		200		230	270	325	395
○ Closed with steel sleeve			180		210		240			
○ Closed with solid housing				200	230	240		310		

Availability on request

The VLINE is all about:

- Vertical machining
- Suitable for tilting operation
- Processing of different materials
- Machining of workpieces with varying geometries
- Use in small and large-scale production
- Short duration until reaching the stable Tool Centre Point (TCP)
- Optional clamps for turning operations
- Optional measuring of the axial shaft displacement

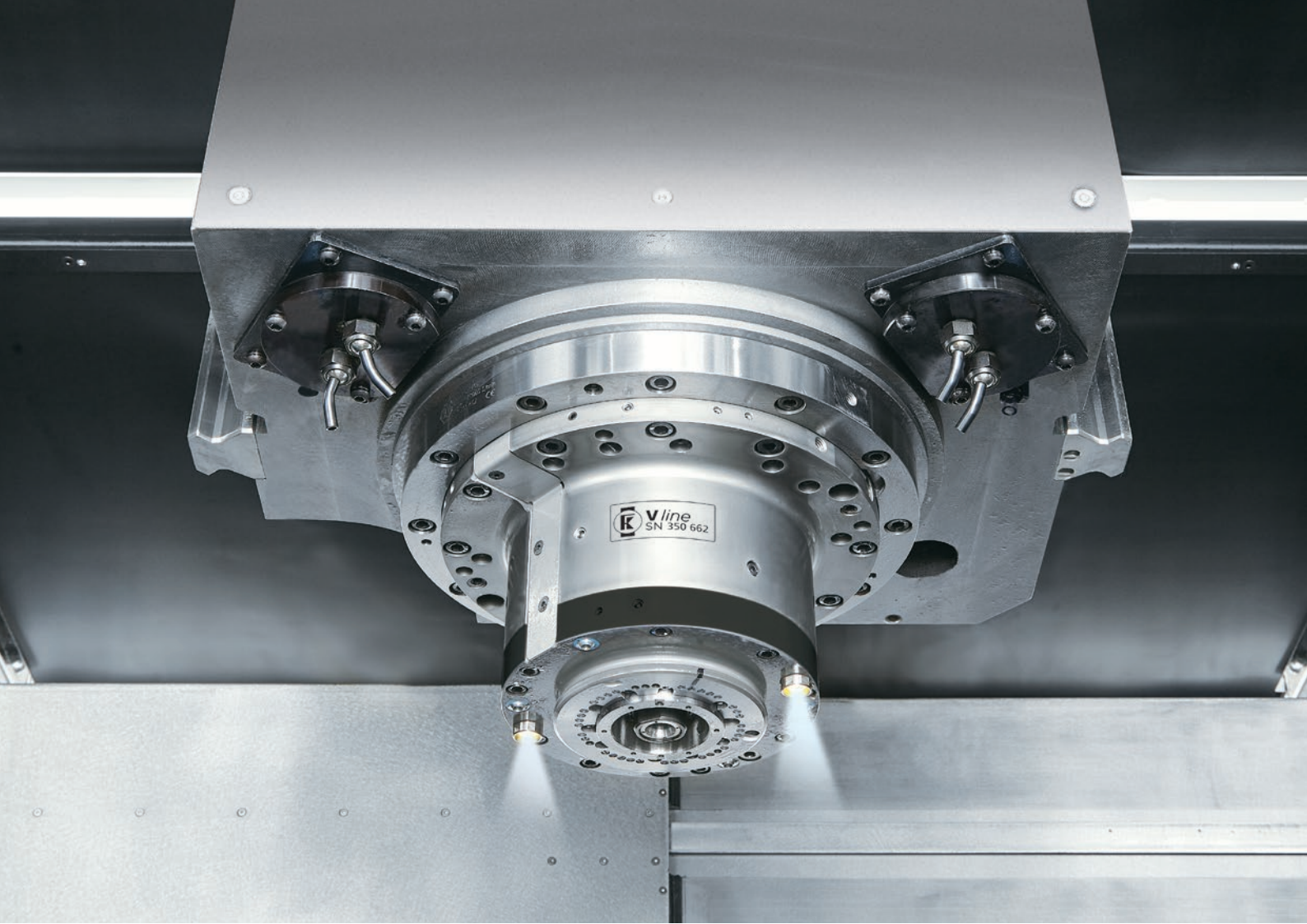

Our V LINE variants

Model	V100	V200	V400
Maximum speed (rpm)	24,000	16,000	15,000
Spindle fitting Ø (mm)	202	230	270
Tool interface	HSK 63 BBT 40/SK 40 Capto C6	HSK 100 SK 50/BBT 50 Capto C8	HSK 100 SK 50/BBT 50 Capto C8

Impress with:

- High flexibility
- Optional shaft clamping
- Tilting operation optional

All advantages of the modular system at a glance

- **Robust**
designed for high load forces in the machining process

- **Bearing preload**
dynamically adaptable to the machining process

- **High degree of operational safety thanks to LEDs**
for optimal illumination of the tool intervention

- **High flexibility**
various tool interfaces available

- **High availability**
with the KESSLER tool clamping system

- **Reduction of TCO (Total Costs of Ownership)**
due to the rapid change of the rotor exchange group (KESSLER QCC)

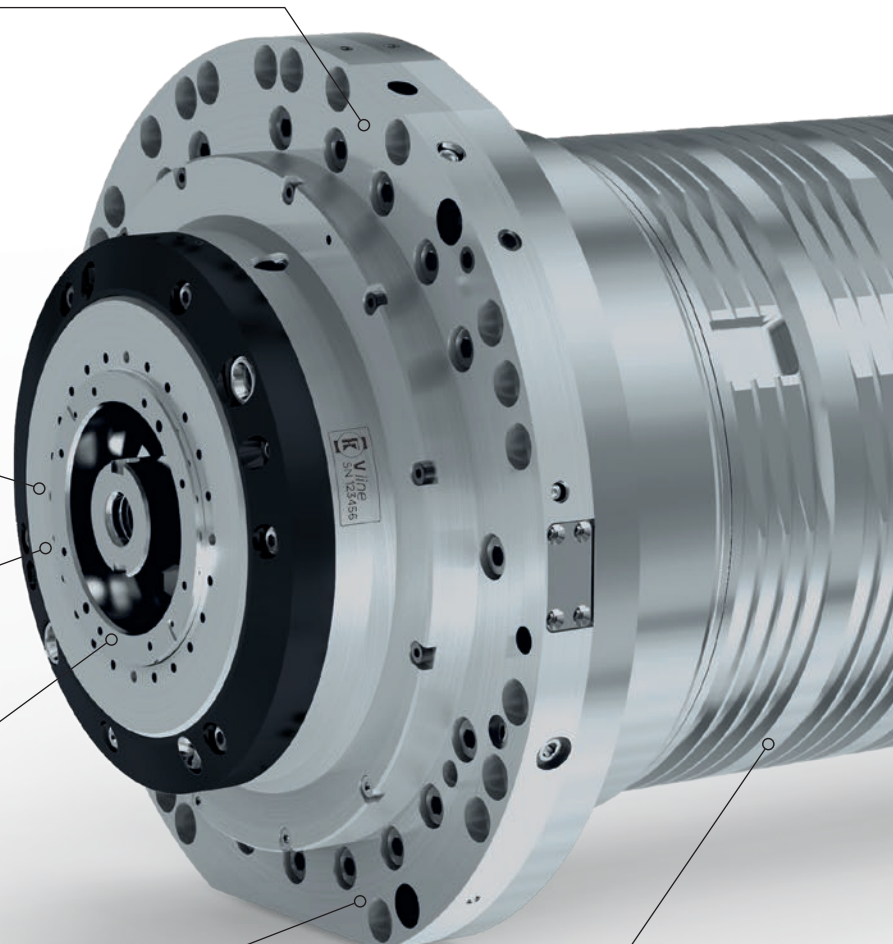

Advantages

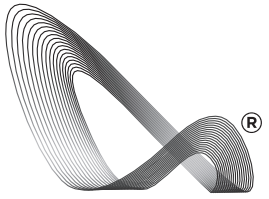

COOLMOTION

- **The most suitable COOLMOTION® motor** for your individual needs: with very high torque, very high speed and high-compact design
- **Various bearing lubrication systems** available
- **Hydraulic, pneumatic or electrical release unit** available
- **High flexibility:** KESSLER rotary union for media: lubrication, dry operation, compressed air, MQL capability
- **Process reliability** due to extensive sensory system
- **Analogue or digital tool clamping status monitoring** available on request
- **Hydraulic clamping** for turning operations available
- **High power density**, due to very compact design and light weight

HIGH QUALITY

MADE IN GERMANY

Milling spindle/V100

- **Spindle fitting:** Ø 202 mm
- **KESSLER COOLMOTION® motor**
- **Rotary union:** Internal coolant supply with high volume flow
- **Cooling:** Open cooling housing
- **Bearing lubrication:** Grease / re-greasing / oil-air

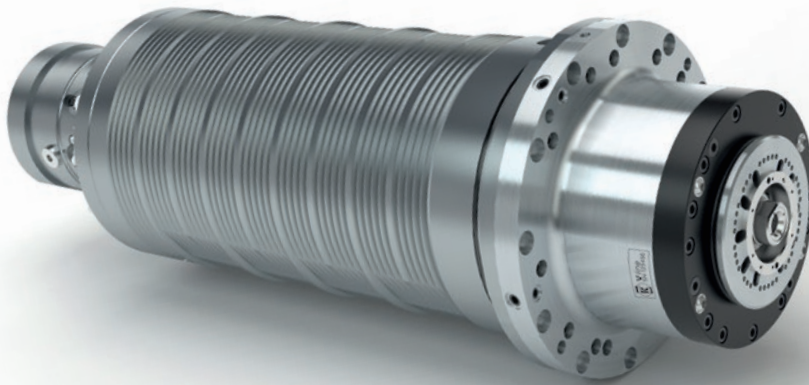

Choose the most suitable COOLMOTION® motor from the list of preferred motors

Model	Max. speed (rpm)	S1		S6 / 40 %		S6 / 25 %		S6 max.	
		Torque (Nm)	Power (kW)	Torque (Nm)	Power (kW)	Torque (Nm)	Power (kW)	Torque (Nm)	Power (kW)
V100-S24	24,000	90	50	110	50	130	50	160	50
V100-A15	15,000	130	30	201*	46	217	50	217	50
V100-A20	20,000	87	25	135*	40	150	44	203	60
V100-A14	14,000	80	15	112	21	129	24.5	141	27

*6 40 % / 25 % DC: 2 min.

Milling spindle / V200

- **Spindle fitting:** Ø 230 mm
- **KESSLER COOLMOTION® motor**
- **Rotary union:** Internal coolant supply with high volume flow
- **Cooling:** Open cooling housing
- **Bearing lubrication:** Grease / re-greasing / oil-air

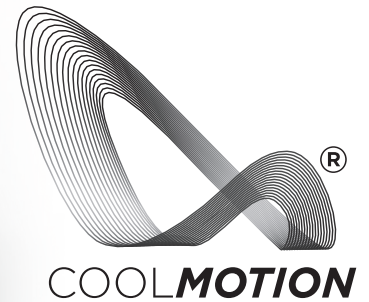
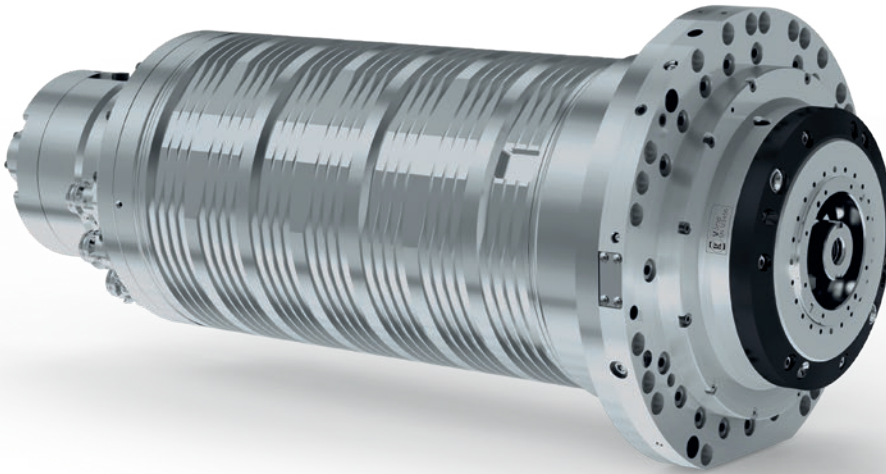

Choose the most suitable COOLMOTION® motor from the list of preferred motors

Model	Max. speed (rpm)	S1		S6 / 40 %		S6 / 25 %		S6 max.	
		Torque (Nm)	Power (kW)	Torque (Nm)	Power (kW)	Torque (Nm)	Power (kW)	Torque (Nm)	Power (kW)
V200-S16	16,000	185	52	205	52	235	52	260	52
V200-S12	12,000	235	54	265	54	305	54	335	54
V200-A14	14,000	180	30	260	43	300	50	300	50

Milling spindle/V400

- **Spindle fitting:** Ø 270 mm
- **KESSLER COOLMOTION® motor**
- **Rotary union:** Internal coolant supply with high volume flow
- **Cooling:** Open cooling housing
- **Bearing lubrication:** Grease / re-greasing / oil-air

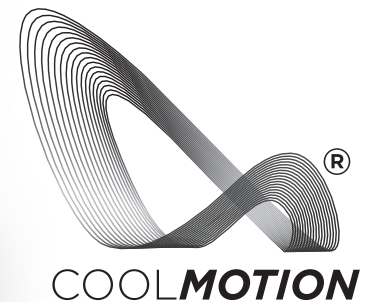
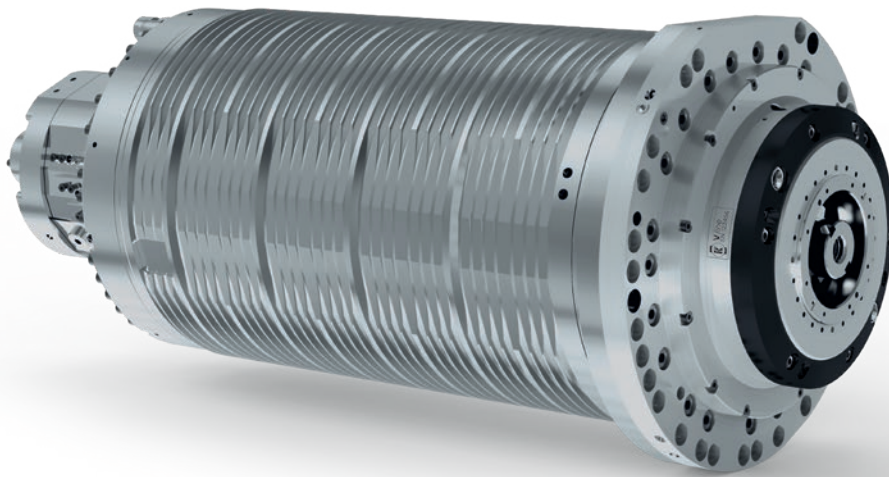

Choose the most suitable COOLMOTION® motor from the list of preferred motors

Model	Max. speed (rpm)	S1		S6 / 40 %		S6 / 25 %		S6 max.	
		Torque (Nm)	Power (kW)	Torque (Nm)	Power (kW)	Torque (Nm)	Power (kW)	Torque (Nm)	Power (kW)
V400-A15	15,000	300	48	445	70	535	84	640	100
V400-A10	10,000	400	50	560	70	690	86	800	100
V400-A15	15,000	220	35	305	48	350	56	405	65



Modular extensions available

- + Choose the most suitable KESSLER COOLMOTION® motor for your needs
- + KESSLER rotary union
 - Coolant
 - Dry operation
 - Compressed air
 - MQL capability
- + Sensor monitoring system
 - Interface control (IFC)
 - Vibration sensor
 - Analogue sensor
 - Eddy current sensor detects axial shaft displacement
 - Clamping status monitoring
 - Clamping monitoring
 - Leakage monitoring
 - Temperature sensor PT100
- + Hydraulic clamping
- + Bearing preload variable
- + Bearing lubrication Grease / re-greasing / oil-air
- + Closed cooling jacket
- + Clamping spring package is designed for 5 million tool changes
- + Holding-function for collet chuck variable
- + 2-channel rotary union

Accessories

- + Oil-air lubrication unit
- + Re-greasing unit
- + Direct lubrication on demand



COOLMOTION

KESSLER COOLMOTION®

COOLMOTION® in drive technology

- Achieves a **very high torque density** with up to **30 % more torque in a minimized design**
- Facilitates a **compact design**
- Achieves a significantly **more robust** design in relation to resonance and reflection effects
- Facilitates **applications even during continuous loads**
- Provides **maximum standstill torque**

KESSLER is the innovation engine behind state-of-the-art direct drive technology and is renowned for powerful and energy-efficient motors with high torque density and top reliability even in high-demand applications. Real-life simulations and customised calculations are the basis of excellence during the development of KESSLER motors.

The inverter-optimized COOLMOTION® motors are recognized for their low-loss design and enhanced heat dissipation. Innovative modifications of the motor components have enabled us to reduce the rotor and stator losses by 25 %. Special construction measures have resulted in significantly enhanced heat dissipation.

The COOLMOTION® technology optimizes efficiency to a maximum.

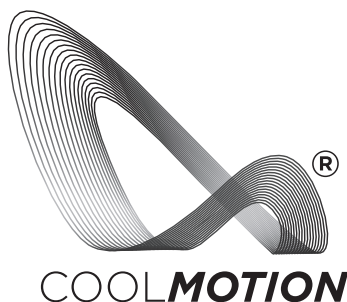

Optimization principle

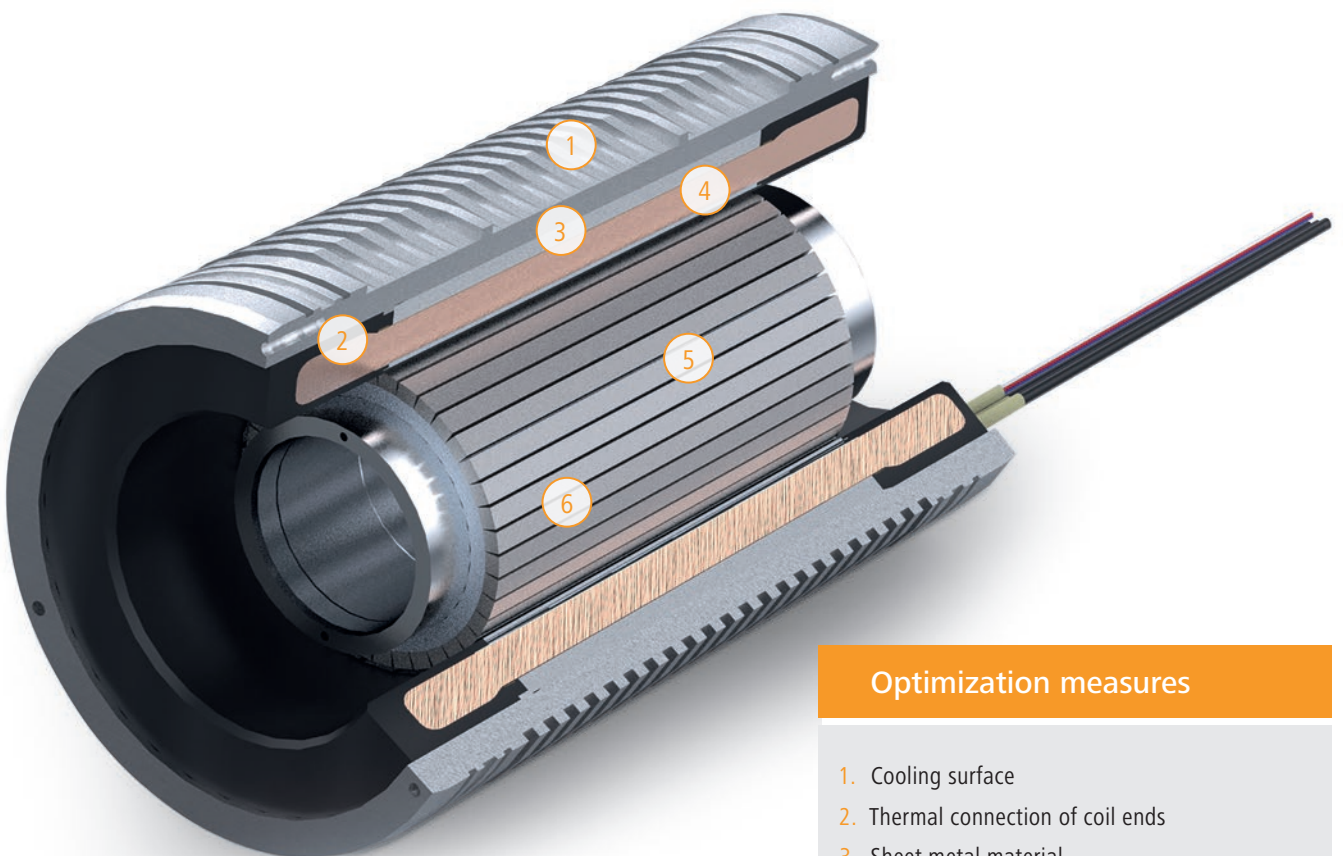
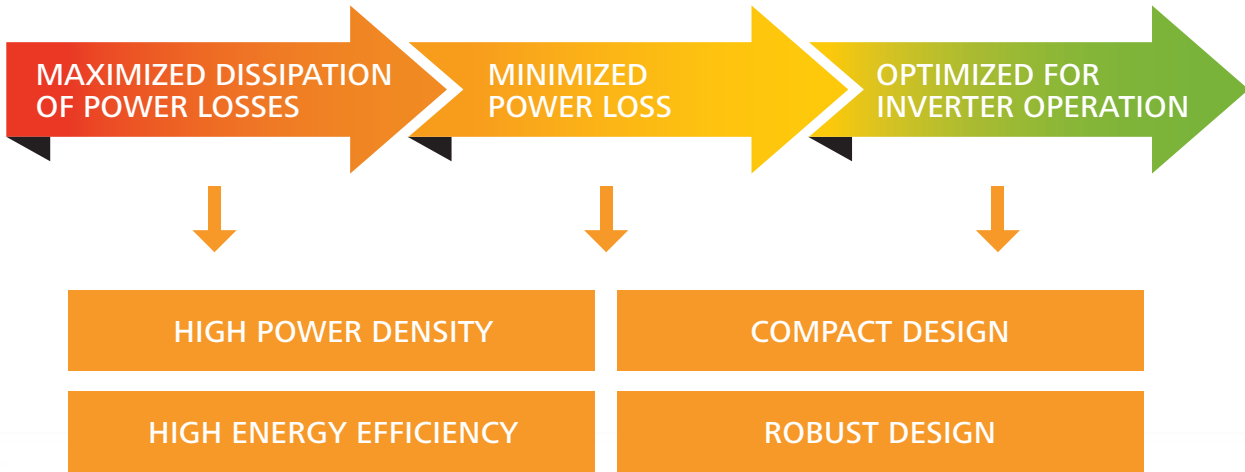

- Optimization measures**
- 1. Cooling surface
 - 2. Thermal connection of coil ends
 - 3. Sheet metal material
 - 4. Thermal connection of stator slots
 - 5. Magnetic materials
 - 6. Design re. additional power loss

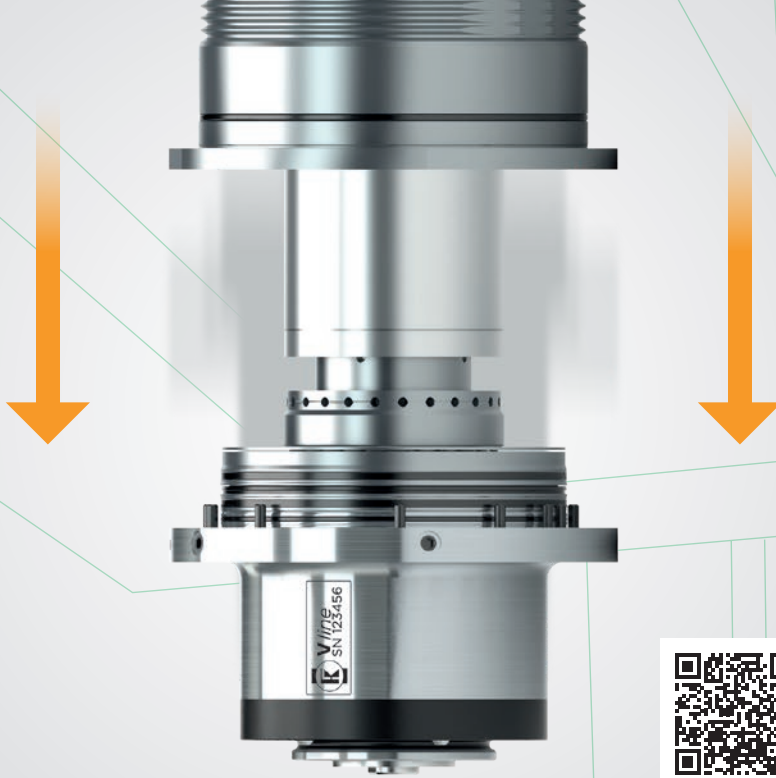

For more information
go online to view
QCC video under
www.kessler-group.biz

The built-in spindle housing remains in the headstock of the machine during the replacement procedure

Quick Connect Cartridge (QCC)



1. DISASSEMBLY OF THE CARTRIDGE FROM THE MOTOR SPINDLE

2. ASSEMBLY OF THE NEW CARTRIDGE

3. RESTARTING OF OPERATION



Fast replacement of rotor shaft, front/rear bearing and power drawbar on-site



Reduces TCO (Total Costs of Ownership)



Reduces machine downtime



No electrician needed

All information has been carefully compiled and checked. The printed illustrations are of an explanatory nature and may differ from the actual design. Contents may change without prior notice due to the continuous development of our products. Availabilities and delivery times are subject to variability and have to be confirmed in each individual case. Subject to modification. EGOE. Photos: Buffalo Machinery Co., Ltd.; © Franz Kessler GmbH, September 2021. Reprinting, even in part, is only permitted with our approval. FK Edition 2021 PK1006-EN-V5.0

A close-up photograph of a Kessler industrial machine. The machine's dark grey upper housing features the Kessler logo, which consists of a stylized 'K' inside a square with rounded corners, followed by the word 'KESSLER' in a bold, white, sans-serif font. Below the housing, a silver-colored metal spindle assembly is visible, ending in a drill bit. The drill bit is positioned just above a large, grey metal component that has a complex, ribbed design. The background is a plain, light-colored wall, and the lighting is soft and directional, highlighting the metallic textures and the precision of the machinery.

 **KESSLER**

Operating Worldwide for our Customers

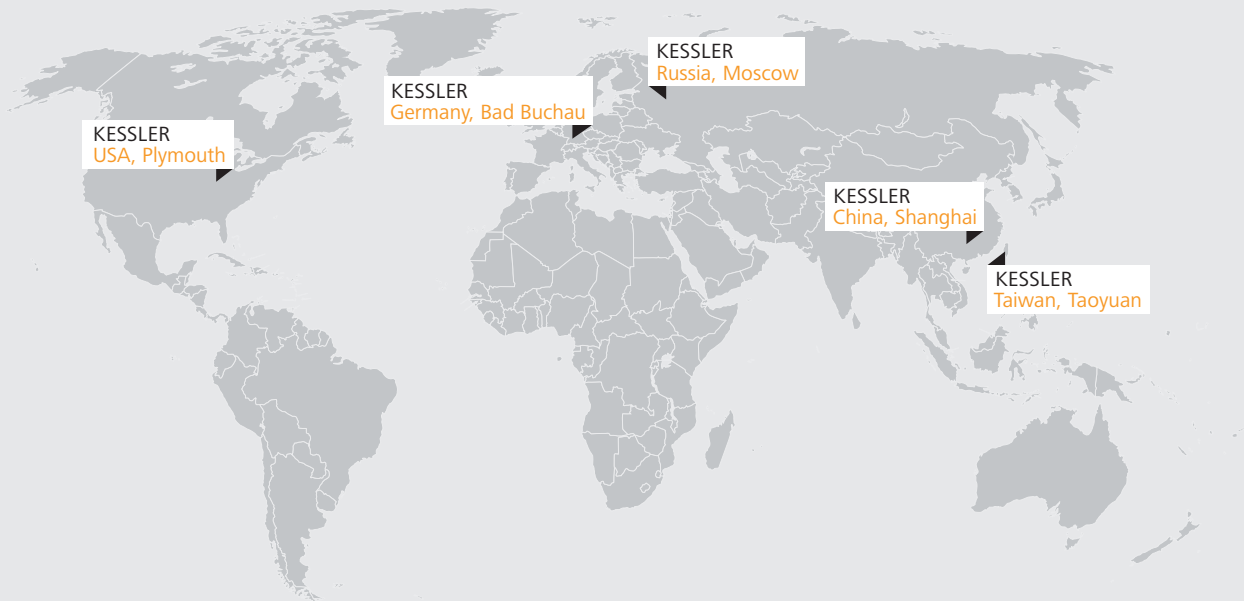

Germany

Franz Kessler GmbH
 Franz-Kessler-Straße 2
 88422 Bad Buchau, Germany
 Tel.: +49 7582 809 - 0
 Fax: +49 7582 809 - 170
info@kessler-group.biz

USA

KESSLER USA Inc.
 44099 Plymouth Oaks Blvd.
 Plymouth, MI 48170, USA
 Tel.: +1 734 404 0152
 Fax: +1 734 404 0153
info.usa@kessler-group.biz

Russia

KESSLER East Ltd.
 Dorogobuzhskaja str., 14, bld. 6
 121354, Moscow, Russia
 Tel.: +7 495 204 2450
info.ru@kessler-group.biz

Taiwan

KESSLER Taiwan Ltd.
 No.347, Sec. 1
 Nanshan Rd
 Luzhu District
 Taoyuan City 33861
 Taiwan (R.O.C.)
 Tel.: +886 3 326 2256
 Fax: +886 3 355 5014
info.tw@kessler-group.biz

China

**KESSLER (Shanghai)
 Spindle Service Co., Ltd.**
 Building #12
 No.318 Yuanshan Rd
 Minhang District
 201108 Shanghai, China
 Tel.: +86 21 6489 7034
 Fax: +86 21 6489 7134
info.cn@kessler-group.biz