

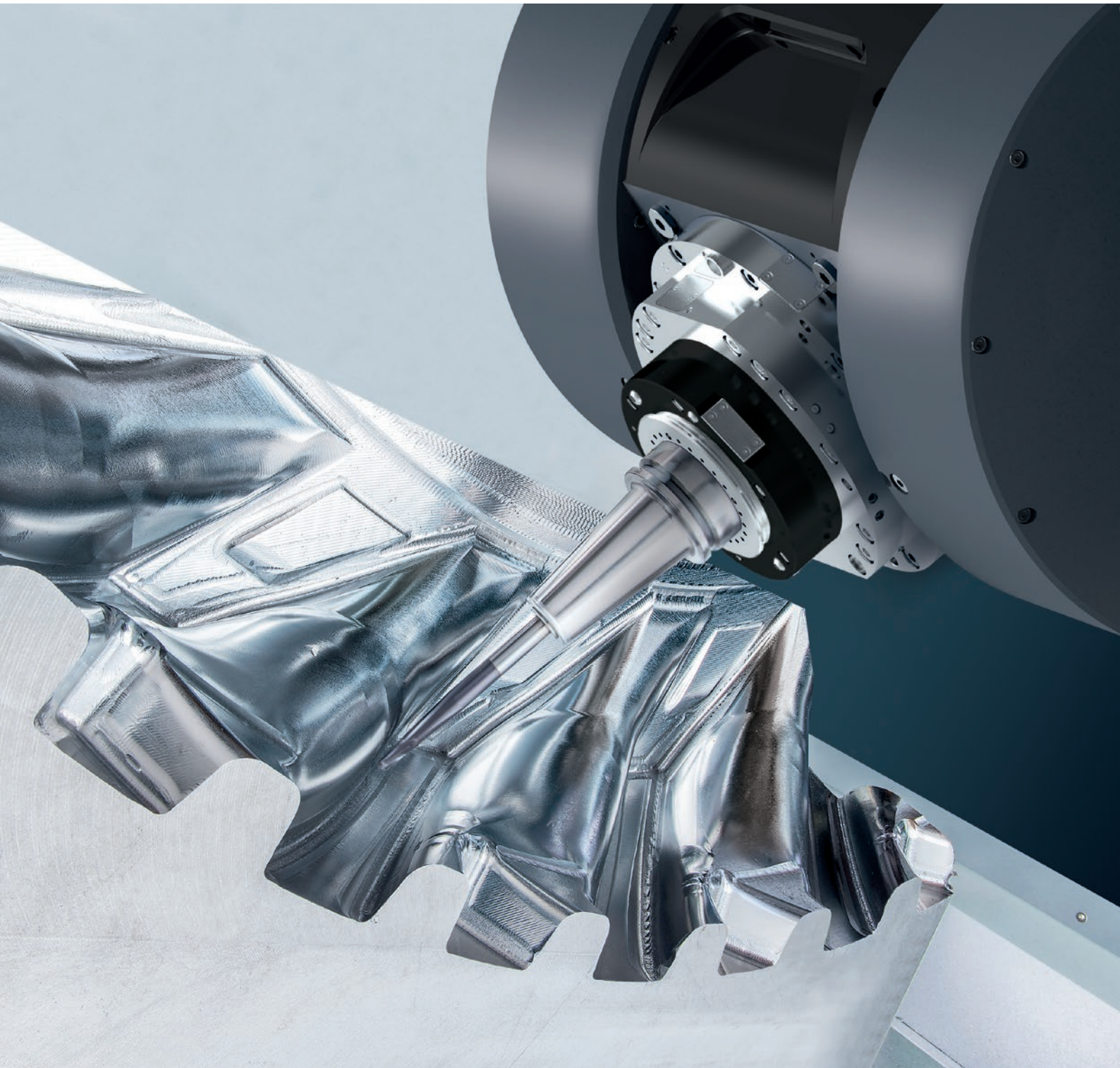

HEADLINE – die Übersicht

Maximale Präzision und Dynamik in der 5-Achs-Bearbeitung



Die Stärksten ihrer Klasse



- **Ein verantwortlicher Kompetenzpartner** – für 2-Achs-Köpfe, Spindeln und Motoren
- **individuelle Konfigurierbarkeit** durch modularen Aufbau
- **hohes Klemmmoment** in der C-Achse
- **hohes Maximaldrehmoment**
- **hohe Genauigkeit**
Sekundärkühlung in der C-Achse reduziert den Wärmeeintrag in den Spindelstock auf ein Minimum
- **sehr wartungsfreundlich**
Verschleißkomponenten können einfach vor Ort getauscht werden
- **Spindeln optional mit Wellenklemmung** für die Drehbearbeitung erhältlich
- **Robustheit** durch einteilige Gabel
- **exakte Bearbeitungsergebnisse** durch hohe Positioniergenauigkeit
- **hochflexibel** – für unterschiedlichste Anwendungen geeignet
- **hohe Produktivität** durch große Schwenkgeschwindigkeit
- **hohes Klemmmoment** in der A-Achse
- **große Dynamik** durch antriebsstarke KESSLER COOLMOTION® Motoren
- **hohe Bedienungssicherheit** mit LEDs durch optimale Ausleuchtung des Werkzeugeingriffs
- **hohe Produktivität** durch den Einsatz von drehmomentstarken Motorspindeln
- **neue Spindelgeneration** MT + PC LINE
- **Quick Connect Cartridge (QCC)***

*Nicht bei MT80 und MT600



Mehr zum Thema QCC unter kessler-group.biz

HIGH QUALITY

MADE IN GERMANY

1-AH mit Befestigungsflansch



C-Achse mit Wechselkopfschnittstelle

+ Einpass-Ø: 540 mm

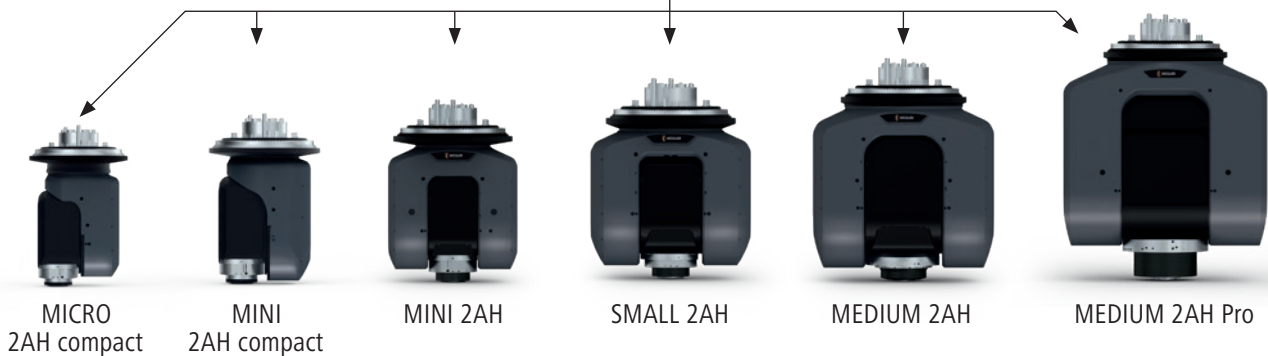





Nutze die Möglichkeiten

Kopfgröße	MICRO compact Einpass-Ø 335	MINI compact Einpass-Ø 335	MINI Einpass-Ø 335	
Spindelgröße	MT80		MT80	
2-axis	MICRO 2AH compact*		MINI 2AH compact	
	  <p>Bis 24.000 1/min, 80 Nm / 45 kW (S1)</p>		  <p>Bis 24.000 1/min, 80 Nm / 45 kW (S1)</p>	
	A-Achse Klemmmoment: 2.000 Nm Drehmoment S1: 175 Nm	C-Achse Klemmmoment: 2.000 Nm Drehmoment S1: 175 Nm	A-Achse Klemmmoment: 2.000 Nm Drehmoment S1: 360 Nm	C-Achse Klemmmoment: 3.000 Nm Drehmoment S1: 560 Nm
	A-Achse Klemmmoment: 3.000 Nm Drehmoment S1: 400 Nm	C-Achse Klemmmoment: 3.000 Nm Drehmoment S1: 560 Nm	Alle 2AHs mit automatischem A-Achsen Wechsel (QAC) oder als 1AH mit festem Befestigungsflansch erhältlich.	

Kopfgröße	SMALL Einpass-Ø 335 + 390			
Spindelgröße	MT100 V100			
1-axis	SMALL 1AH-B			
	1AH-B	  <p>B-Achse Klemmmoment: 3.000 Nm Drehmoment S1: 560 Nm</p> <p>Bis 20.000 1/min, 200 Nm / 54 kW (S1)</p>	  <p>B-Achse* Klemmmoment: 3.000 Nm Drehmoment S1: 560 Nm</p> <p>Bis 24.000 1/min, 130 Nm / 30 kW (S1)</p>	
		1AH-B-45	  <p>B-Achse* Klemmmoment: 3.000 Nm Drehmoment S1: 560 Nm</p> <p>Bis 20.000 1/min, 200 Nm / 54 kW (S1)</p>	  <p>B-Achse* Klemmmoment: 3.000 Nm Drehmoment S1: 560 Nm</p> <p>Bis 24.000 1/min, 130 Nm / 30 kW (S1)</p>

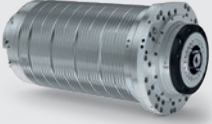
* Verfügbarkeit auf Anfrage

SMALL Einpass-Ø 335 + 390		MEDIUM Einpass-Ø 480 + 540		MEDIUM Pro Einpass-Ø 540	
MT100		MT400		MT500	
SMALL 2AH		MEDIUM 2AH		MEDIUM 2AH Pro	
					
Bis 20.000 1/min, 200 Nm / 54 kW (S1)		Bis 15.000 1/min, 500 Nm / 75 kW (S1)		Bis 6.000 1/min, 1.015 Nm / 66 kW (S1)	
A-Achse Klemmmoment: 4.000 Nm Drehmoment S1: 1.100 Nm	C-Achse Klemmmoment: 4.000 Nm Drehmoment S1: 1.139 Nm	A-Achse Klemmmoment: 7.400 Nm Drehmoment S1: 2.200 Nm	C-Achse Klemmmoment: 12.500 Nm Drehmoment S1: 2.500 Nm	A-Achse Klemmmoment: 7.400 Nm Drehmoment S1: 3.020 Nm	C-Achse Klemmmoment: 12.500 Nm Drehmoment S1: 2.500 Nm

MEDIUM Einpass-Ø 480 + 540					
MT400 V400					
MEDIUM 1AH-B					
					
B-Achse		B-Achse*		B-Achse*	
Klemmmoment: 12.500 Nm Drehmoment S1: 2.500 Nm		Klemmmoment: 12.500 Nm Drehmoment S1: 2.500 Nm		Klemmmoment: 12.500 Nm Drehmoment S1: 2.500 Nm	
Bis 15.000 1/min, 500 Nm / 75 kW (S1)		Bis 15.000 1/min, 550 Nm / 75 kW (S1)		Bis 15.000 1/min, 500 Nm / 75 kW (S1)	
Bis 15.000 1/min, 500 Nm / 75 kW (S1)		Bis 15.000 1/min, 550 Nm / 75 kW (S1)		Bis 15.000 1/min, 500 Nm / 75 kW (S1)	

Für unsere Kunden weltweit im Einsatz

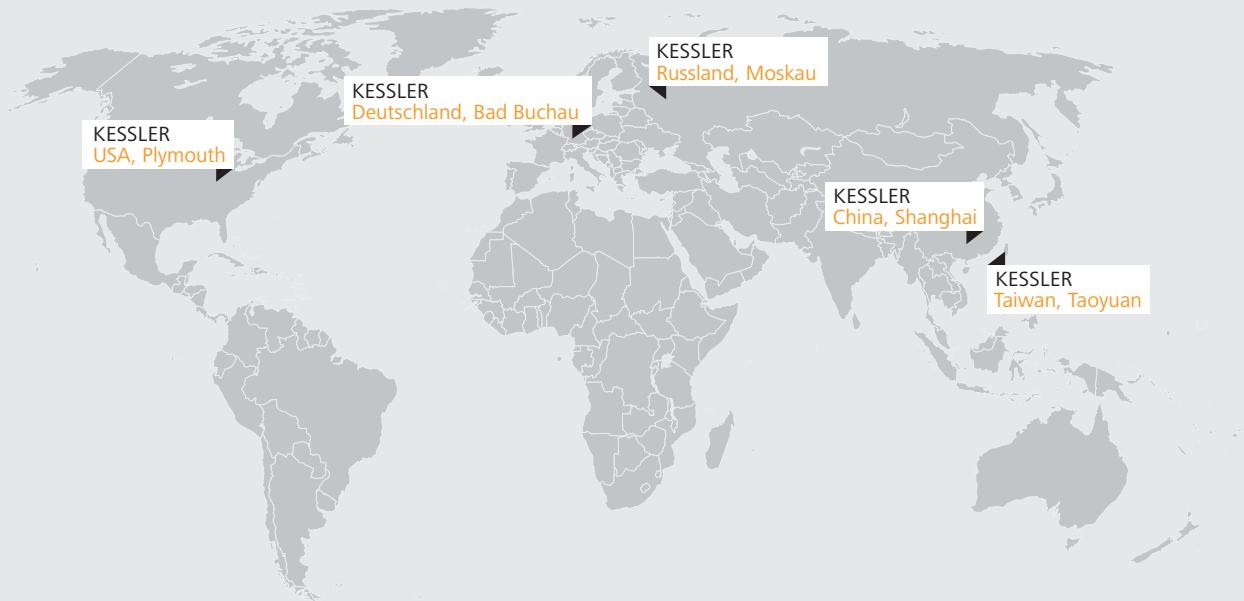

Deutschland

Franz Kessler GmbH
 Franz-Kessler-Straße 2
 88422 Bad Buchau, Deutschland
 Tel.: +49 7582 809 - 0
 Fax: +49 7582 809 - 170
info@kessler-group.biz

USA

KESSLER USA Inc.
 44099 Plymouth Oaks Blvd.
 Plymouth, MI 48170, USA
 Tel.: +1 734 404 0152
 Fax: +1 734 404 0153
info.usa@kessler-group.biz

Russland

KESSLER East Ltd.
 Dorogobuzhskaja str., 14, bld. 6
 121354, Moskau, Russland
 Tel.: +7 495 204 2450
info.ru@kessler-group.biz

Taiwan

KESSLER Taiwan Ltd.
 No.347, Sec. 1
 Nanshan Rd
 Luzhu District
 Taoyuan City 33861
 Taiwan (R.O.C.)
 Tel.: +886 3 326 2256
 Fax: +886 3 355 5014
info.tw@kessler-group.biz

China

**KESSLER (Shanghai)
 Spindle Service Co., Ltd.**
 Building #12
 No.318 Yuanshan Rd
 Minhang District
 201108 Shanghai, China
 Tel.: +86 21 6489 7034
 Fax: +86 21 6489 7134
info.cn@kessler-group.biz